

# Romag

GLASS SPECIALIST

CI/SfB

Ro

October 2009



**Power** GLAZ RI<sup>®</sup>  
ENERGY IN GLASS

ROOF INTEGRATED SOLAR TILE  
BY ROMAG

## PowerGlaz RI® Roof Integrated Solar Tiles by Romag.

### Why choose the PowerGlaz® RI system?

Solar energy offers pollution free, silent, renewable energy which does not produce any 'green-house' gases.

The PowerGlaz® RI system is Romag's answer to providing cost effective solar energy for domestic houses. It provides the house builder with a complete roof integrated solar tile system. The system combines Romag's experience in producing high quality PowerGlaz® PV products with a market proven fixing system which is suitable for roof integration compatible with most slate and tile systems or as a 'total roof' system.

### The PowerGlaz® RI system package includes:

- High Efficiency PowerGlaz® RI 6 series polycrystalline PV modules
- Market proven roof integration system factory fitted to the module for easy site assembly
- All associated fixing clips
- Factory fitted connectors for interconnecting the solar tiles
- Inverter and associated cabling for converting Direct Current (DC) into Alternating Current (AC)

The PowerGlaz® RI 6(32)P module converts daylight into DC electricity and when converted into AC, is used by the householder in preference to energy drawn from the National Grid, thus providing cheap, clean, green electricity.

### Can the 'Solar' electricity be stored for night use?

It is not necessary to store electricity; the system is 'grid connected' allowing excess energy to be 'stored' in the National grid and drawn back from the grid at night. From April 2010 the UK government is to introduce 'Feed in Tariffs' (FIT) which will enable households to 'sell' electricity back to the electricity supplier at a much higher rate than electricity purchased from the suppliers (subject to meeting Micro-generation Certification Scheme [MCS] requirements). This enables the system to be potentially self financing.

### Will the house be worth more money?

The Energy Savings Trust have conducted research indicating that renewable energy can help to increase the house value by up to 10%. This is for an investment of less than 5%.

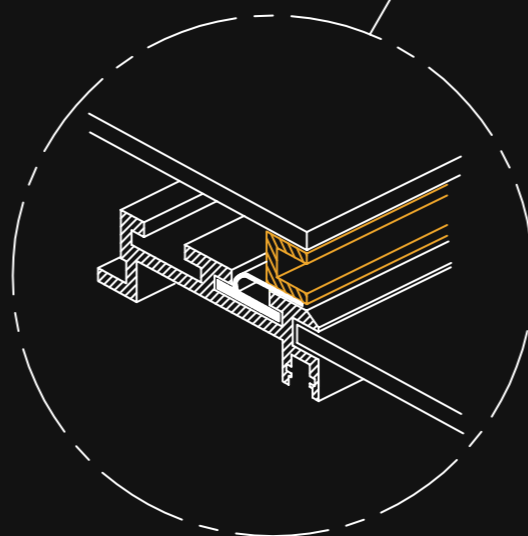
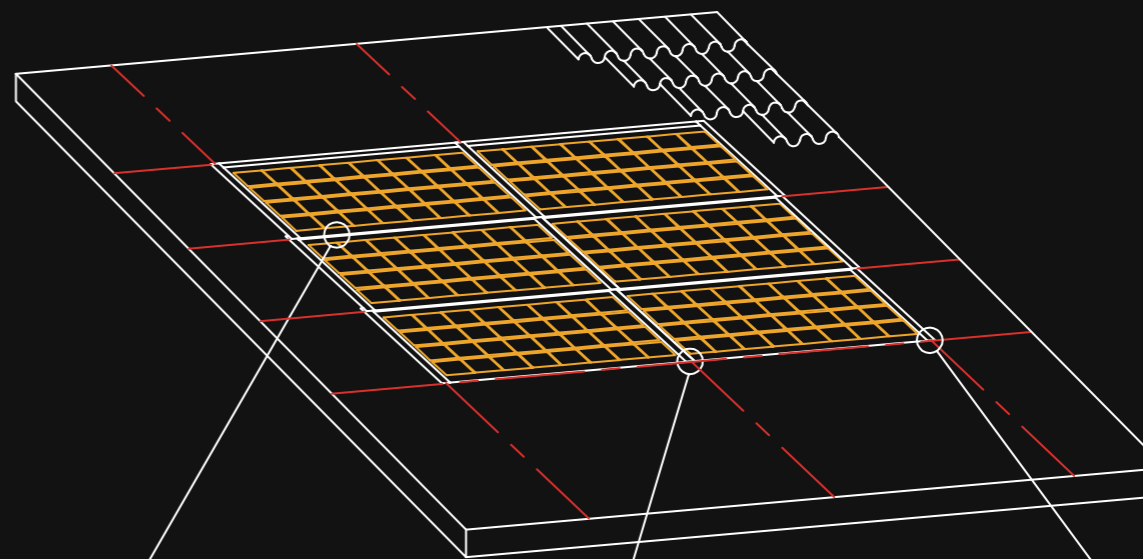

SECTION

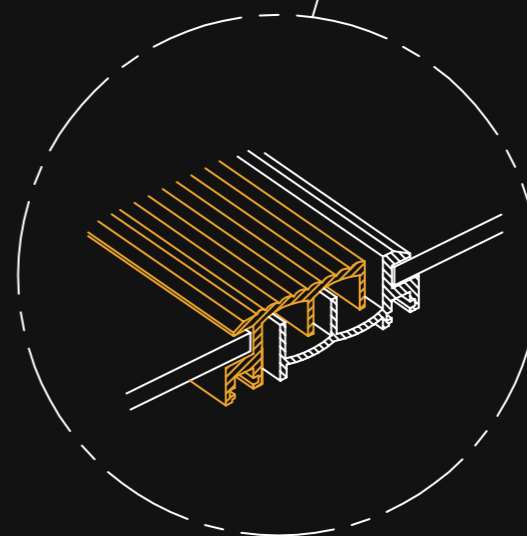

VERTICAL OVERLAP

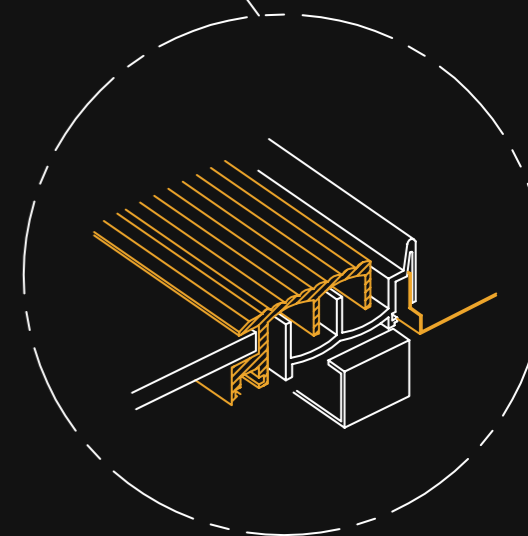

RIGHT SIDE EDGE  
(LEFT OPP. HAND)

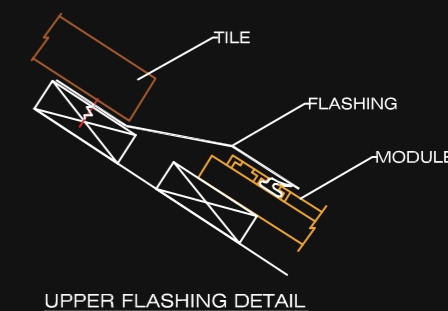

UPPER FLASHING DETAIL

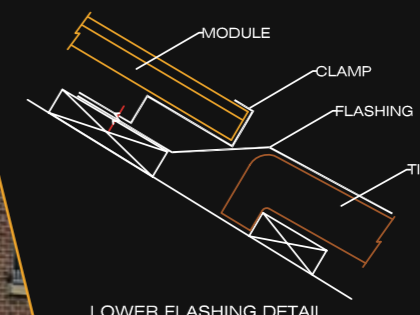

LOWER FLASHING DETAIL

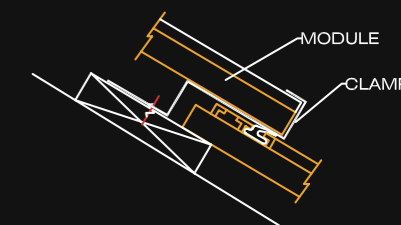

PANEL OVERLAP DETAIL

### Will we get planning permission?

Local Authority planners are under increasing obligation to allow the use of renewable energy within homes but some renewable energy options are considered unsightly and therefore not suitable. PowerGlaz® RI is a discreet system which neatly integrates into the roof and in some applications, is virtually unseen. It is the ideal solution for demanding Planners and for use in conservation areas.

### Can PowerGlaz® RI be installed on any house?

Provided the installation has a south facing aspect (no more than 90° from due south) then PowerGlaz® RI is effective. It can be used on any pitched roof applications.

### What maintenance is required?

The PowerGlaz® RI system is a 'passive' system with no moving parts to wear out, and if installed at an angle of 20° or more, it is self cleaning.

### Who installs the PowerGlaz® RI system?

The PowerGlaz® RI solar tile is fixed to standard tiling battens and is easily installed by the roofer or builder. Installation instructions are provided and these can also be downloaded on [www.powerglaz.co.uk](http://www.powerglaz.co.uk). The electrical installation should be carried out by an MCS accredited installer.

(Note: From 2010 Romag will be offering accredited training courses tailored for builders, roofers, and designers; these will be held at Romag's new Solar Business & Training Centre in County Durham)

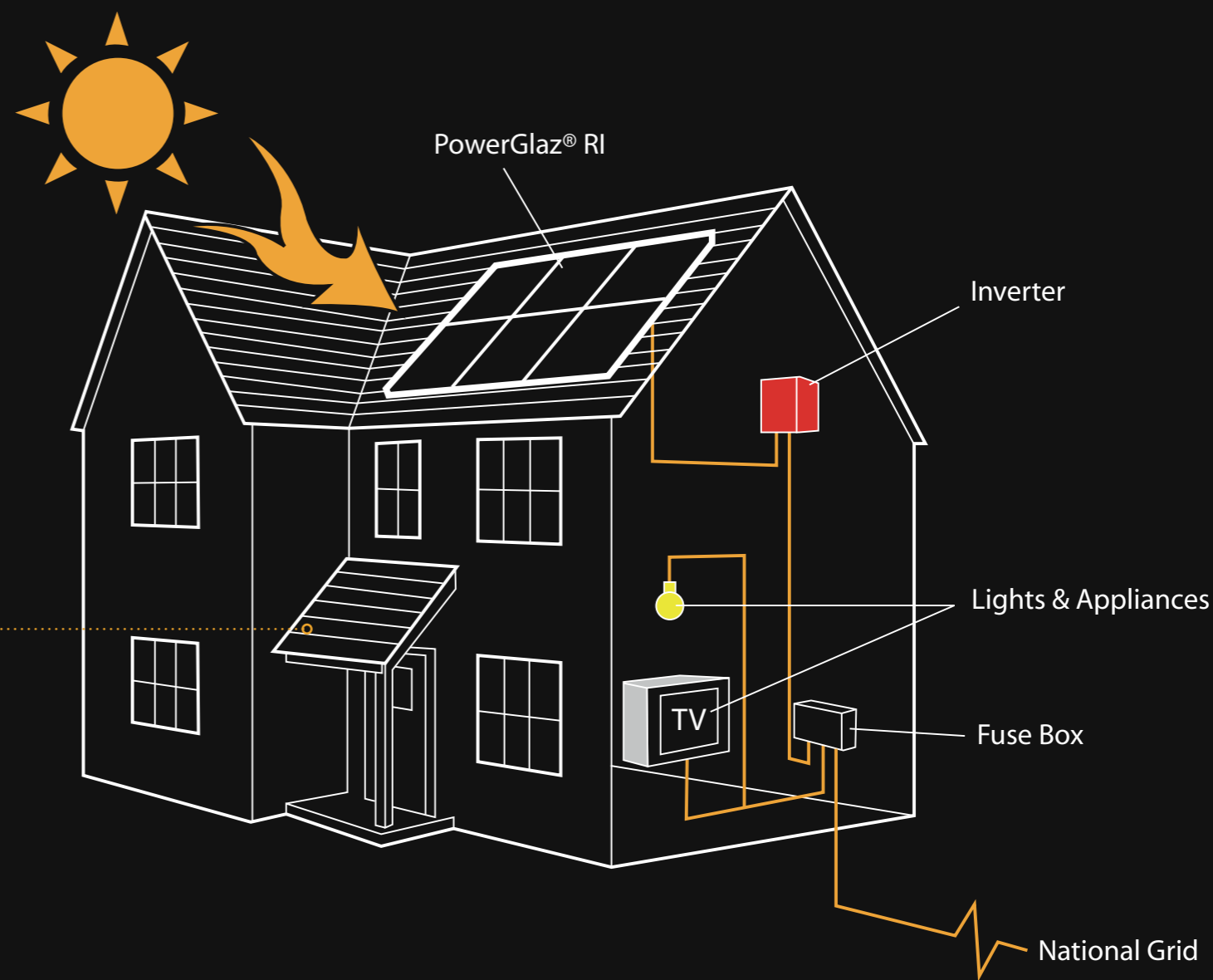

## How does it work?

- 01. The PowerGlaz RI solar tiles generate DC power by converting daylight into electricity
- 02. The DC electricity is converted into AC by an inverter(s)
- 03. The AC electricity is fed via the fuse box to household appliances
- 04. Excess power is fed to the 'grid' where (if eligible) Feed in Tariffs will be paid to the householder

## TECHNICAL INFORMATION

### PowerGlaz® Roof Intergrated module performance

Module	Voc	Isc	Pmp	Vmp	Imp	FF	Voc Coef.	Isc Coef.
RI 6(48)	29.8	8.3	180	23.1	7.8	72.6	-106mV/oC	3.85mA/oC
RI 6(32)	19.7	8.2	120	15.4	7.7	0.75	-72mV/oC	3.85mA/oC
RI 6(18)	11	8.2	66	8.6	7.7	0.75	-40mV/oC	3.85mA/oC
RI 6(12)	7.4	8.2	45	5.8	7.7	0.75	-27mV/oC	3.85mA/oC

### PowerGlaz® Roof Intergrated module dimensions

Module	Length (mm)	Width (mm)	Weight (Kg)
RI 6(48)	1362	1020	17
RI 6(32)	1352	692	11.5
RI 6(18)	1510	375	7
RI 6(12)	1036	375	5

PowerGlaz RI modules certified to IEC 61215 ed 2 and IEC 61730

### OTHER PowerGlaz® PRODUCTS

The PowerGlaz® range includes:

- Semi transparent glass/glass laminates for integration into curtain wall and roof glazing system
- MCS approved SMT6 series standard modules.



- Roof mounted solutions
- Canopies
- Louvres
- PowerPark charging stations for new generation electric vehicles



FOR INFORMATION ON THESE AND OTHER PowerGlaz® PRODUCTS PLEASE VISIT [www.powerglaz.co.uk](http://www.powerglaz.co.uk)

The information given in this brochure may be subject to change without warning. Please check with our technical department prior to ordering.

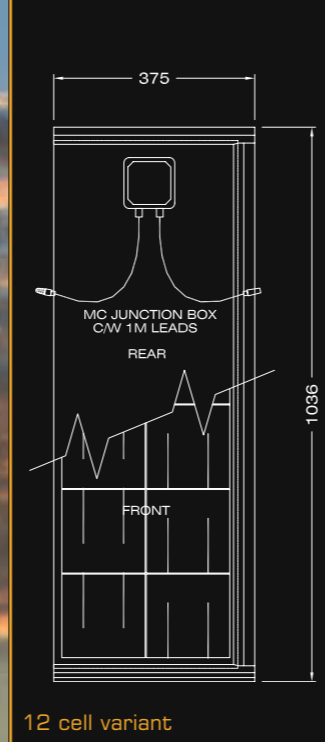

12 cell variant

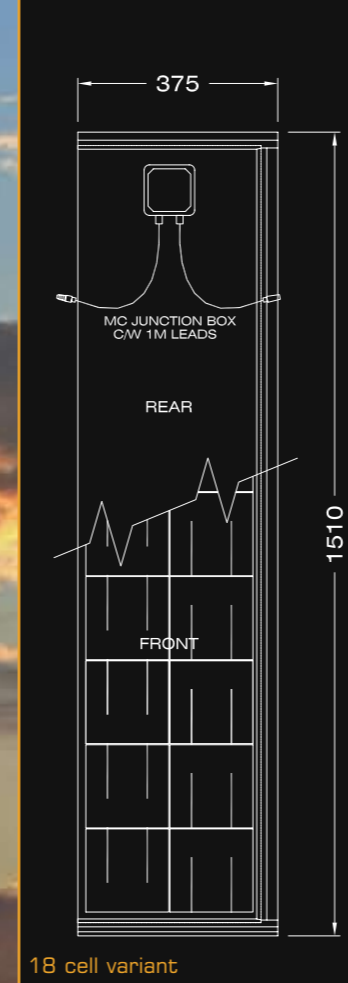

18 cell variant

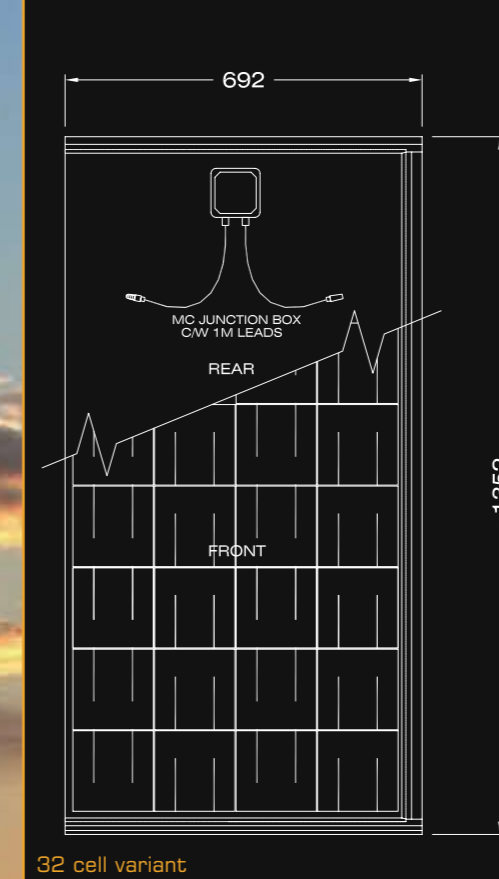

32 cell variant

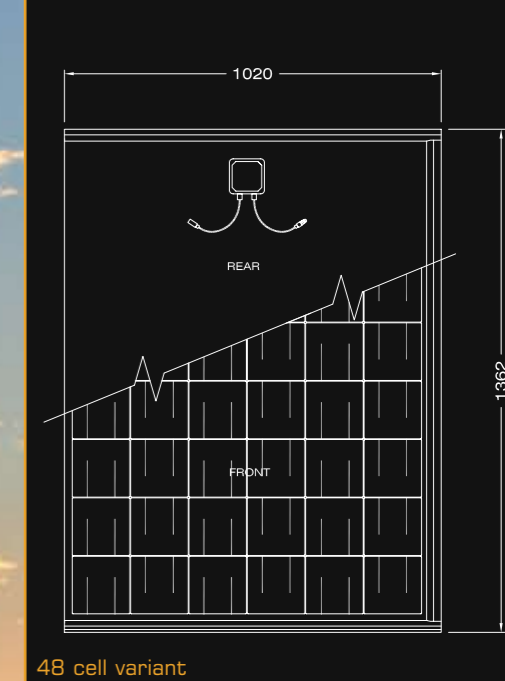

48 cell variant



**PowerGLAZ RI**<sup>®</sup>  
ENERGY IN GLASS

**Romag**  
GLASS SPECIALIST

Romag Ltd, Leadgate Industrial Estate, Leadgate, Consett, County Durham DH8 7RS  
T: 01207 500 000 F: 01207 591 979 E: info@romag.co.uk W: www.romag.co.uk